

A&D WEIGHING

ION SERIES



Microbalances | Semi-Microbalances | Analytical Balances

A&D
A&D Weighing
...Clearly a Better Value

MICROBALANCES

The Ion Series – The Practical Solution for Weighing Micrograms.

Weighing is at the heart of many laboratory processes and the Ion Series offers the features, performance and standard accessories to bring real convenience to your lab. With the six balances of the Ion Series, you can choose a capacity as high as 520 g or a microbalance with readability down to 1 µg. The BM-20 and BM-22 let you handle with confidence even trace quantities of valuable or degradable substances.

Critical to precision weighing is static control, which is why the direct current fanless ionizer is standard on all models.

The automatic response adjustment function uses environmental data from built-in sensors to compensate the balance's characteristics to deliver fast and stable results. Calibration is also automatic and always available with a single key press. A range of accessories add extra convenience.

Microgram (µg) Measurements Made Simpler.

The BM-20 and BM-22 microbalances have the performance and standard accessories to simplify microgram measurements. The Ion Series now makes microgram (µg) measurements accessible to all researchers and offers a real choice in microbalances.

Ion Model	Capacity	Resolution
BM-20	22 g	0.001 mg (1 µg)
BM-22 (Smart Range)	5.1 g	0.001 mg (1 µg)
	22 g	0.01 mg (10 µg)
BM-252	250 g	0.01 mg (10 µg)
BM-200	220 g	0.1 mg
BM-300	320 g	0.1 mg
BM-500	520 g	0.1 mg

Removable Separation Plate

Enables weighing of taller objects in all models.



Large Weighing Chamber Improves Usability

The Ion Series offers more space and convenience than conventional 1µg balances that use a secondary breeze break.

Innovative Draft Shields



The BM-20 and BM-22 have a novel double-ring structure around the weighing pan, making an inner breeze break unnecessary.

Bright LCD

The high-contrast, backlit LCD provides excellent readability.

Automatic Response Function

The balance adjusts its response time (FAST, MED, SLOW) by analyzing the effects of drafts and vibrations on measurement stability.

SEMI-MICROBALANCES

Built-in Fanless Ionizer

The internal ionizer neutralizes charged samples and is standard on all BM models.

Anti-static Glass Breeze Break

Clear metal coating on glass minimizes the effects of static.



Press the ION key to neutralize static. The green LED is lit while the ionizer is on.

10,000 Hour Lifetime

The electrode discharge pins are also safely replaceable by the user.



The “door” symbol is displayed until both doors are completely closed.

Automatic Self Calibration

The balance can self-calibrate automatically when it detects a change in ambient temperature.

Twelve Units of Weighing

g, mg, oz, ozt, ct, dwt, grain, momme, tael, tola, messghal, pieces (counting mode) and % (percent mode).

Built-in Sensors Monitor the Environment:

- Temperature
- Humidity
- Vibration
- Atmospheric Pressure

ANALYTICAL BALANCES

Eliminate One of the Major Frustrations in Precision Weighing.

The Challenge.

Static, while often overlooked, can seriously degrade precision weighing. An electrostatically charged object induces the opposite charge in nearby objects. The resulting attraction causes inaccuracies as shown below.

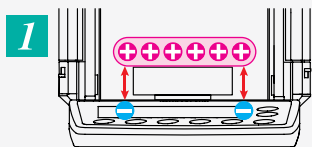

1 Error when weighing a charged object

The object will appear heavier. The value then changes as static electricity is dissipated into the air or via the weighing pan.

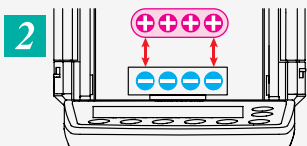

2 Error when a charged object approaches

The apparent value will shift in the negative direction. Static attraction from a charged object, like clothing (frequent in dry winters) can cause values to drift.

Filter papers, disposable weigh boats and plastic centrifuge containers can all become charged just from normal handling. And charged powders can be displaced, causing cross-contamination.

The A&D Solution

Better, Safer Measurements.

Understanding and removing static electricity is critical to accurate weighing. The built-in ionizer improves weighing by eliminating static. And because we use the direct current (DC) method, the ionizer needs no fan. So, you can neutralize static in fine powders without the risk of compromising your sample.

Static control is so important we made the built-in ionizer standard in all Ion Series balances. Simply hold the sample in the upper neutralizing chamber for a few seconds before weighing.



Interlocking Doors

Use this feature to open either door from the opposite side, or open both doors with one hand. You work more quickly and efficiently when you can use both hands.

Units of Measure

MODEL	BM-20	BM-22	BM-252	
g	Capacity	22	5.1 / 22	250
	Readability	0.000001	0.000001 / 0.00001	0.00001
mg	Capacity	22000	5100 / 22000	250000
	Readability	0.000001	0.001 / 0.01	0.01
oz	Capacity	0.776	0.18 / 0.776	8.82
	Readability	0.0000001	0.0000001 / 0.000001	0.000001
ozt	Capacity	0.707	0.164 / 0.707	8.03
	Readability	0.0000001	0.0000001 / 0.000001	0.000001
ct	Capacity	110	25.5 / 110	1250
	Readability	0.00001	0.00001 / 0.0001	0.0001
mom	Capacity	5.87	1.36 / 5.87	66.67
	Readability	0.000001	0.000001 / 0.00001	0.00001
dwt	Capacity	14.15	3.28 / 14.15	160.7
	Readability	0.000001	0.000001 / 0.00001	0.00001
GN	Capacity	339.5	78.71 / 339.5	3858
	Readability	0.00002	0.00002 / 0.0002	0.0002

MODEL	BM-200	BM-300	BM-500	
g	Capacity	220	320	520
	Readability		0.0001	
mg	Capacity	220000	320000	520000
	Readability		0.1	
oz	Capacity	7.76	11.29	18.34
	Readability		0.00001	
ozt	Capacity	7.07	10.29	16.72
	Readability		0.00001	
ct	Capacity	1100	1600	2600
	Readability		0.001	
mom	Capacity	58.7	85.3	138.7
	Readability		0.0001	
dwt	Capacity	141.5	205.8	334.4
	Readability		0.0001	
GN	Capacity	3395	4938	8024
	Readability		0.002	

Dimensions (mm/inches)

MODEL	BM-20/22	BM-252/200/300/500
Pan diameter (A in drawing)	25 / 0.98	90 / 3.54

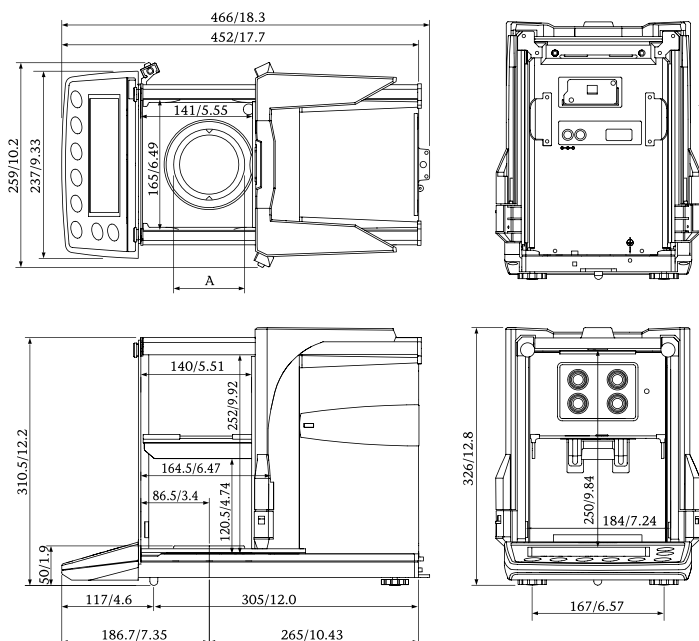

Standard Accessories and Features

All BM Series balances come with the AD-1688 Data Logger, A&D WIN-CT software, and are compliant with GLP / GMP / GCP / ISO industry best practices.



RS-232 and USB ports are standard on all BM Series balances.

AD-1688 Weighing Data Logger

Stores up to 5,000 weighing results with date, time, temperature, humidity and atmospheric pressure. Download to a PC via USB port.



Dedicated Weighing Pans for BM-20/22

The BM-20 and BM-22 include two filter weighing pans, designed to minimize the influence of drafts.



Also included with the BM-20 and BM-22 are holders for micro-centrifuge tubes and 3 sizes of disposable aluminum pans with diameters of 8, 12, 15 mm.

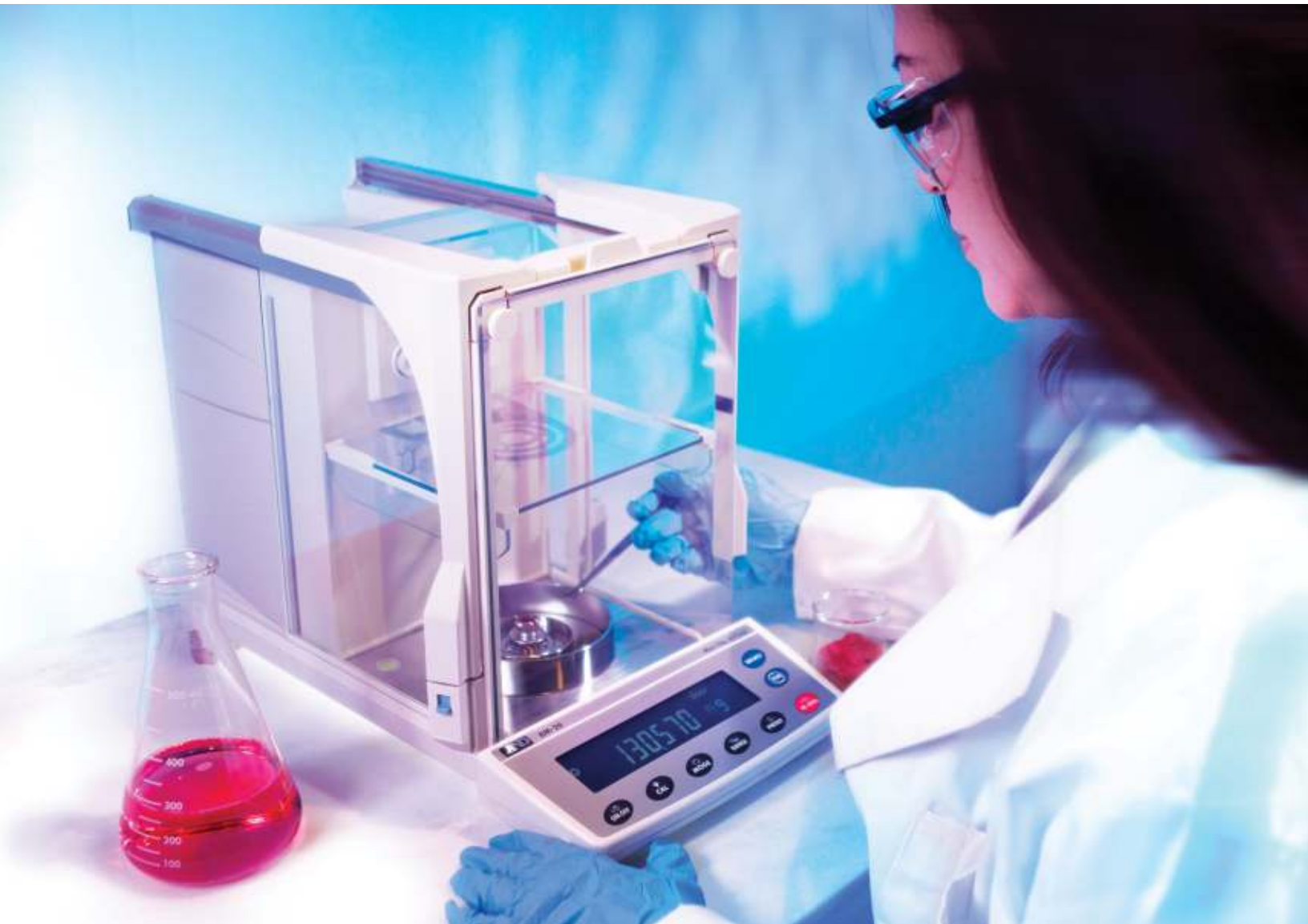

ION SERIES

BM Series Specifications

MODEL	BM-20	BM-22	BM-252	BM-200	BM-300	BM-500
Weighing capacity	22 g	5.1 g / 22 g ¹	250 g	220 g	320 g	520 g
Minimum weighing value	0.001 mg	0.001 mg / 0.01 mg	0.01 mg	0.1 mg		
Repeatability (Standard Deviation)	0.0025 mg (for 1 g)	0.004 mg (for 1 g) / 0.01 mg	0.03 mg (for 100 g)	0.1 mg	0.2 mg	
Linearity	±0.010 mg	±0.010 mg / ±0.02 mg	±0.010 mg	±0.2 mg	±0.3 mg	±0.5 mg
Stabilization time (set to FAST)	Approx. 10 sec.	Approx. 10 / 8 sec.	Approx. 8 sec.	Approx. 3.5 sec.		
Sensitivity drift (10 °C to 30 °C)	±2 ppm / °C (When automatic self calibration is not used)					
Operating temperature	5 °C to 40 °C (41 °F to 104 °F), 85% RH or less (non-condensing)					
Display refresh rate	5 times / second or 10 times / second					
Measurement Units (Display mode)	g, mg, oz, ozt, ct, momme, dwt, GN, tael, tola, messghal, pieces (counting mode), % (percent mode), Specific gravity					
Counting mode	Minimum unit mass = 0.1 mg / Number of samples = 10, 25, 50 or 100 pieces					
Percent mode	Minimum 100% ref. mass = 10.0 mg / Minimum 100% display = 0.01%, 0.1%, 1% (depends on the reference mass stored)					
Internal Memory	200 sets weighing data / 100 sets with date & time / 50 sets of calibration data					
External Data Logger	Store up to 5,000 weighing results with date & time to AD-1688 (standard)					
Data Output	GLP / GMP / GCP / ISO compliant. Outputs: balance manufacturer, model, s/n, balance identification number, data, time of calibration, mass used, and space for signature.					
Standard interface	RS-232C, Quick USB, External key plug for optional foot switch (SW:128)					
Internal calibration	Motor-driven internal calibration					
External calibration masses (g)	20, 10, 5, 2, 1		200, 100, 50, 20, 10	200, 100, 50	300, 200, 100, 50	500, 300, 200, 100, 50
Ionizer electrode pin life	Approx. 10,000 hours of continuous use. (User replaceable)					
Weighing pan diameter	25 mm (50 mm, 95 mm for weighing filters)			90 mm		
Power consumption	Approx. 30 VA (supplied by the AC adapter)					
External dimensions / Weight	259 (W) x 466 (D) x 326 (H) mm / Approx. 10 kg					
Standard accessories	AC adapter, Instruction manual, WinCT (CD-ROM), Weighing Data Logger (AD-1688), Long Tweezers for calibration mass (AD-1689), Standard Tweezers. BM-20/22 also includes two filter weighing pans, microfuge holders and 3 sizes of disposable pans.					

¹ Smart range function: The minimum weighing value switches to 0.01 mg automatically when the display value exceeds 5.1 g but returns to 0.001 mg by pressing the RE-ZERO (tare) key.

Options

- BM-08² Ethernet interface with WinCT-Plus software
- BM-14 Pipette Accessory Testing Kit

² BM-08 and the standard Quick USB interface cannot be used at the same time.



Option BM-14

Accessories

- AD-1653 Density determination kit (for BM-252/200/300/500 only)
- AD-1670 Anti-vibration Table (slab)
- AD-1672 Tabletop Breeze Break
- AD-1682 Rechargeable battery unit
- AD-1684 Electrostatic Fieldmeter
- AD-1688 Weighing Data Logger³
- AD-1689 Tweezers for calibration weight³
- AD-1192 Compact printer
- AD-8121B Statistical printer
- AD-8920A Remote display
- AD-8922A Remote controller
- AX-BM-031 Display covers (5 pcs)
- AX-BM-NEEDLESET Electrode units
- KO:WW9/9 RS-232C cable (9p-9p, 2 m)
- SW:128 Foot switch
- AX-T-314A-S External key plug
- AX-USB-2920-9P Serial/USB converter

³ Included as standard with any BM Series balance

